

Preliminary

The contents of this document are confidential and must not be disclosed wholly or in part to any third part without the prior written consent of AMPIRE CO., LTD



晶采光電科技股份有限公司
AMPIRE CO., LTD.

SPECIFICATIONS FOR LCD MODULE

CUSTOMER	
CUSTOMER PART NO.	
AMPIRE PART NO	AM-480272H2TMQW-TA0H
APPROVED BY	
DATE	

- Approved For Specifications
 Approved For Specifications & Sample

AMPIRE CO., LTD.

2F., No.88, Sec. 1, Sintai 5th Rd., Sijhih City, Taipei County 221,
Taiwan (R.O.C.)台北縣汐止市新台五路一段88號2樓(東方科學園區D棟)
TEL:886-2-26967269 , FAX:886-2-26967196 or 26967270

APPROVED BY	CHECKED BY	ORGANIZED BY

Preliminary

The contents of this document are confidential and must not be disclosed wholly or in part to any third part without the prior written consent of AMPIRE CO., LTD

RECORD OF REVISION

Revision Date	Page	Contents	Editor
2009/07/22	-	New Release	Emil
2009/11/17	23-24	Update Outline Dimension (Add a stiffener under component area of FPC)	Edward

Preliminary

The contents of this document are confidential and must not be disclosed wholly or in part to any third part without the prior written consent of AMPIRE CO., LTD

1. FEATURES

- (1) Construction : a-Si TFT-LCD with driving system, White LED Backlight.
- (2) LCD type : Transmissive , Normally White
- (3) Number of the Colors : 16.7M colors (R,G,B 8 bit digital each)
- (4) RGB Interface 40 pin.
- (5) LCD Power Supply Voltage : 3.3V single power input,

2. PHYSICAL SPECIFICATIONS

Item	Specifications	unit
Display size (diagonal)	4.3	inch
Resolution	480RGB (W) x 272(H)	dots
Display area	98.7 (W) x57.5 (H)	mm
Pixel pitch	0.198 (W) x 0.198 (H)	mm
Overall dimension	105.5(W)x114.05(H)x5.05 (D)	mm
Color configuration	R.G.B Vertical stripe	
View Direction (Gray Inversion)	6 o'clock	

3. ABSOLUTE MAXIMUM RATINGS

item	Symbol	Values		Unit	Remark
		Min	Max		
Power Supply for logic	VCC	-0.3	5.0	V	GND=0
Operation Temperature (Ambient)	T _{OP}	-20	70	°C	
Storage Temperature (Ambient)	T _{ST}	-30	80	°C	Note 1
LED Forward current	I _f		20	mA	OneLED/Note2
LED Power Dissipation	P _d		64	mW	One LED

*TFT LCD Ratings

Note 1: Hsync, Vsync, DEN, DCLK, R0~R7, G0~G7, B0~B7

Note 2: Background color changes slightly depending on ambient temperature. This phenomenon is reversible.

Preliminary

The contents of this document are confidential and must not be disclosed wholly or in part to any third part without the prior written consent of AMPIRE CO., LTD

3.1 Power Voltage

item	Symbol	Values			Unit	Remark
		Min	Typ	Max		
Logic power supply	VCC	2.7	3.0	3.6		

4. OPTICAL CHARACTERISTICS

Item	Symbol	Condition	Min.	Typ.	Max.	Unit	Note
Response Time	$T_r + T_f$	$\Theta = \Phi = 0^\circ$	-	40		ms	(3)
Contrast ratio	CR				250	-	-
Viewing Angle	Vertical	$CR \geq 10$		90.	-	Deg.	(4)
	Horizontal			130	-		
Luminance	L	$\Theta = \Phi = 0^\circ$	--	400	--	cd/m ²	(2)
Color chromaticity	White		Wx		0.301		(2)(3)
			Wy		0.339		

NOTE :

Measure Condition: IL= 20.0mA

Measure Item Definition as follow :

(1)Definition of Contrast Ratio : (Measured by BM-7 (TOPCON) [dark room])

Contrast Ratio (CR)= (White) Luminance of ON ÷ (Black) Luminance of OFF

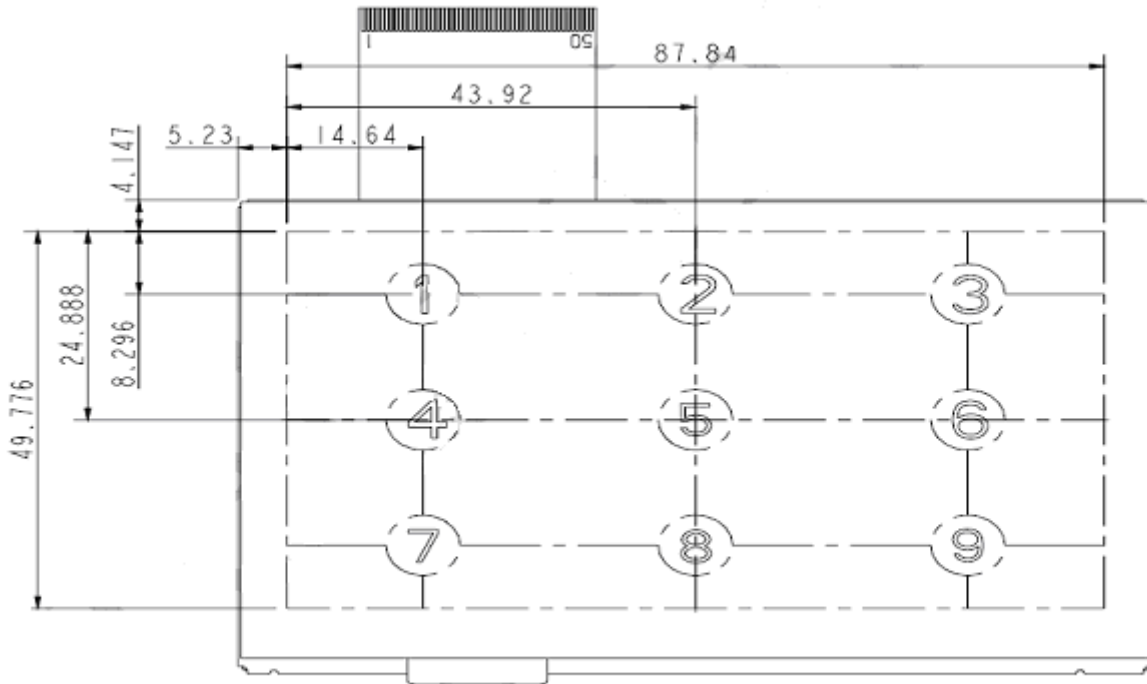

Fig.9-1: Test Point Position

Preliminary

The contents of this document are confidential and must not be disclosed wholly or in part to any third part without the prior written consent of AMPIRE CO., LTD

(2) Definition of Center Luminance & Luminance Uniformity : (Measured by BM-7 (TOPCON) [dark room])

Center Luminance : Measure luminance on Point No5 as figure 9-1.

Luminance Uniformity : Measure maximum luminance(L(MAX))and minimum luminance (L(MIN))on the 9 points as figure 9-1.

$$L = [L(MIN)/L(MAX)] \times 100\% \Delta$$

(3) Response Time (White - Black)

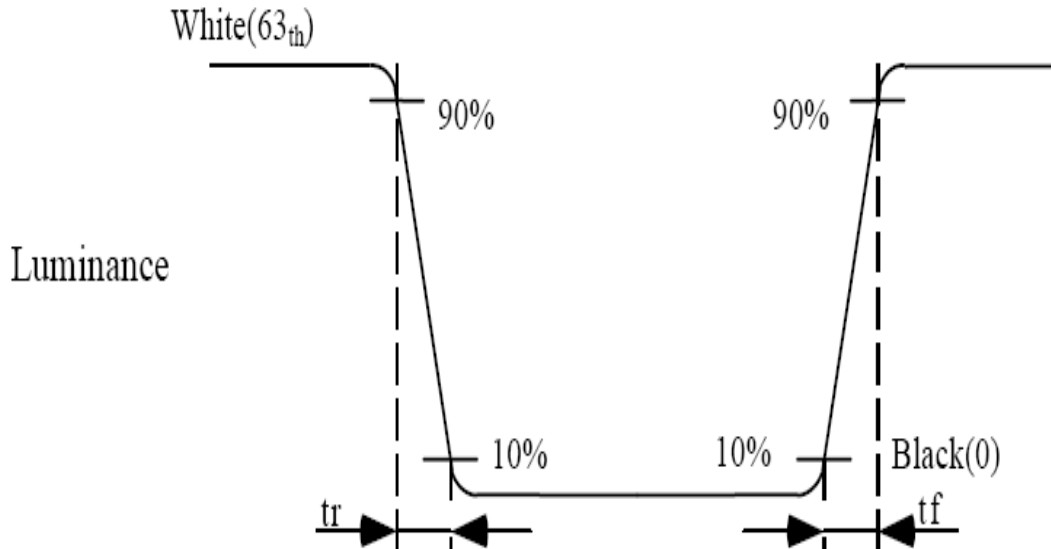
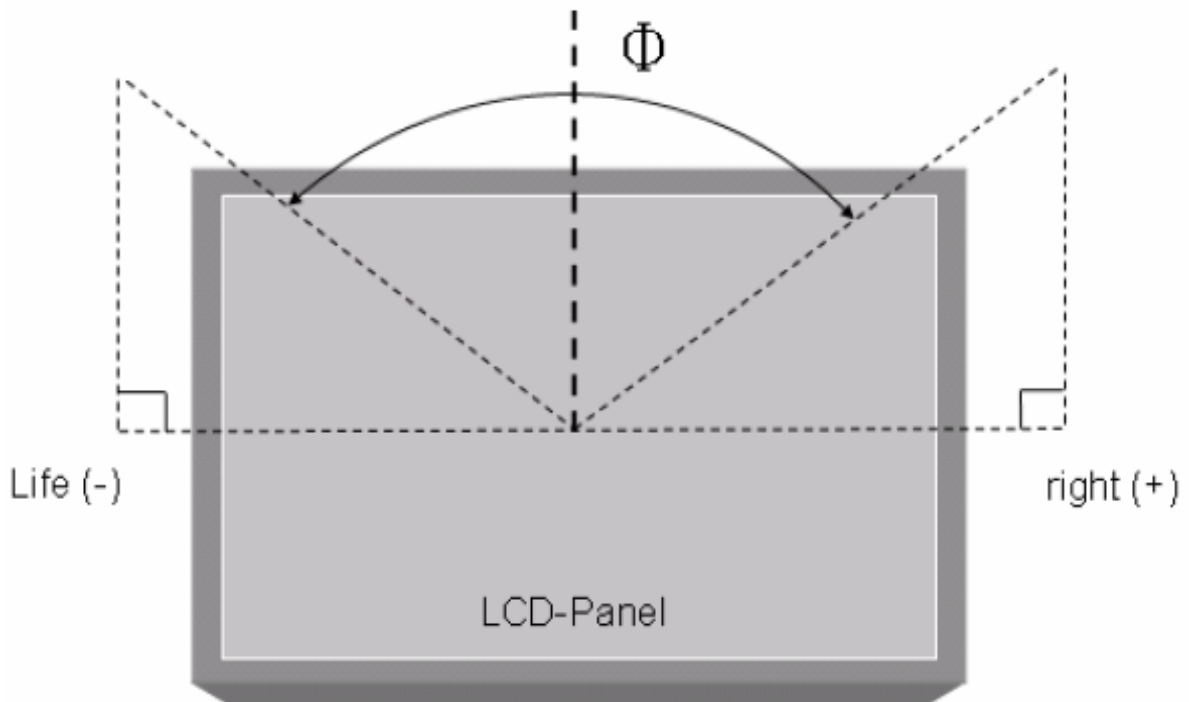
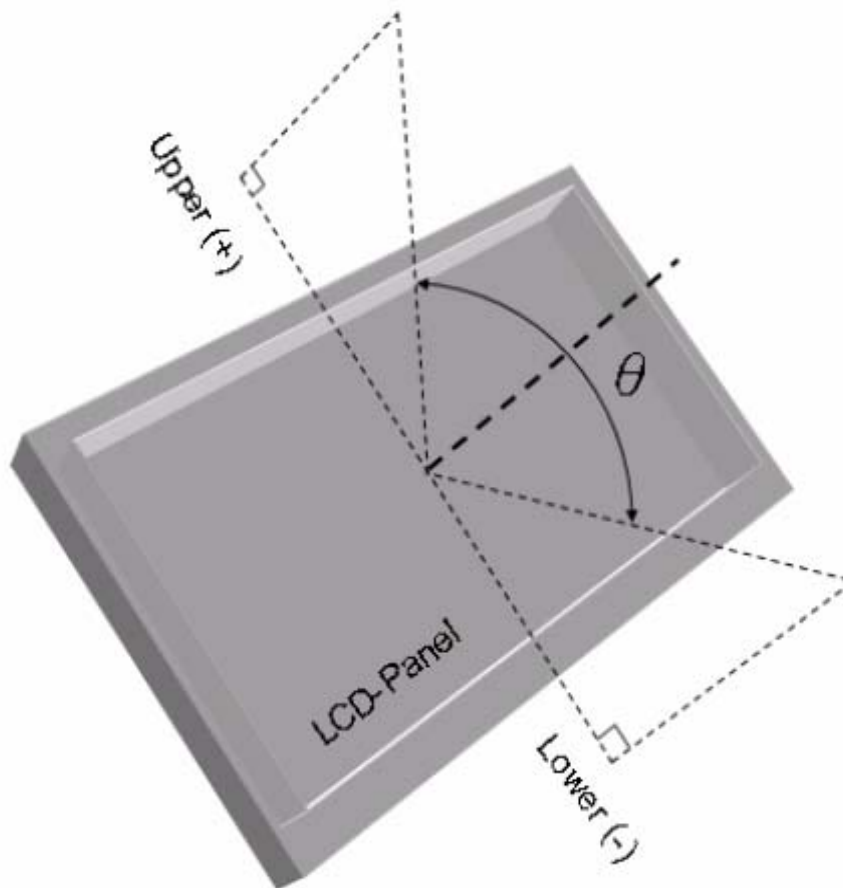

Fig.9-2: Definition of Response Time (White - Black)

(4) Definition of Viewing Angle.() : (by EZ-CONTRAST (ELDIM) in the dark room.)





5. ELECTRICAL CHARACTERISTICS

LCD driving

Item	Symbol	Min.	Typ.	Max.	Unit	Note
Power supply voltage	VDD	3.0	3.3	3.6	V	
Input voltage for logic	H Level	V_{IH}	0.8 VDD	--	VDD	(1)
	L Level	V_{IL}	0	--	0.2 VDD	
Power Supply current	IDD	--	45	--	mA	(2)

Note 1: Hsync, Vsync, DEN, DCLK, R0~R5, G0~G5, B0~B5

Note 2: $f_V = 60\text{Hz}$, $T_a = 25^\circ\text{C}$, Display pattern : All Black

Preliminary

The contents of this document are confidential and must not be disclosed wholly or in part to any third part without the prior written consent of AMPIRE CO., LTD

LED back light specification

Item	Symbol	Conditions	MIN.	TYP.	MAX.	Unit
Forward voltage	V_f	$I_f = 18\text{mA}$		23.1		V
Forward current	I_f	7-chip serial	-	18	20	mA
Uniformity (with L/G)	-	$I_f = 18\text{mA}$	75%*1	-	-	
Life Time (LED Dice)	-	$T_a = 25^\circ\text{C}$, $I_f = 20\text{mA}$	17.7K			Hrs
Luminous color	White					
Chip connection	7 chip serial connection					

- The constant current source is needed for white LED back-light driving. When LCM is operated over 60 deg.C ambient temperature, the I_{LED} of the LED back-light should be adjusted to 15mA max

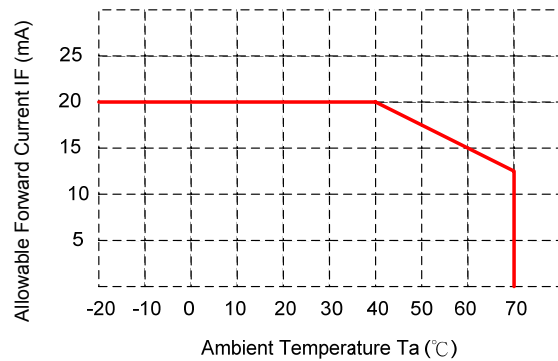
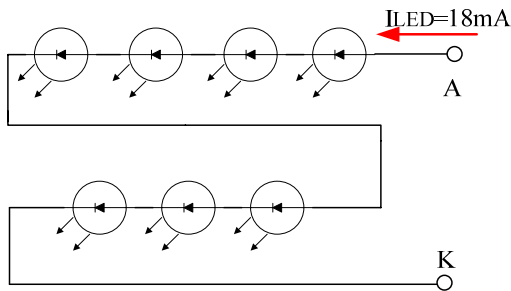

Pin definition of Backlight

Pin no	Symbol	Function
1	LED_K	LED Cathode
2	NC	Keep NC
3	NC	Keep NC
4	LED_A	LED Anode

Preliminary

The contents of this document are confidential and must not be disclosed wholly or in part to any third part without the prior written consent of AMPIRE CO., LTD

Touch Panel Electrical Specification

Parameter	Condition	Standard Value
Terminal Resistance	X Axis	340 ~ 1090 Ω
	Y Axis	180 ~ 470 Ω
Insulating Resistance	DC 25 V	More than 20M Ω
Linearity	--	± 1.5 %
Pen writing Durability	Note a	100,000 times(min)
Input life by finger	Note b	1,000,000 times (min)

Note A .

Writing length 35 mm.

Writing speed: 300mm/sec.

Shape of pen end : R0.8

Load : 250 g

Note B

By Silicon rubber tapping at same point

Shape of rubber end : R8

Load : 200g

Frequency : 5 Hz

Interface

No.	Symbol	Function
1	YU	Touch Panel Top Signal
2	XL	Touch Panel Left Signal
3	YD	Touch Panel Bottom Signal
4	XR	Touch Panel Right Signal

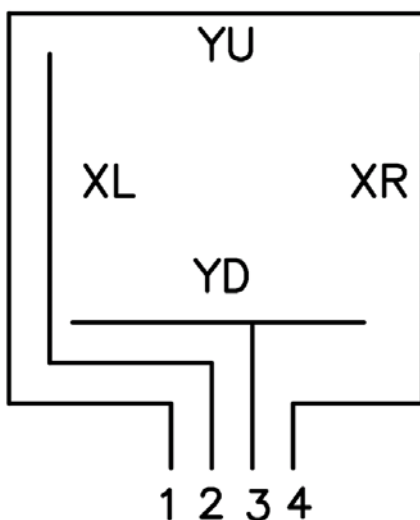

6. BLOCK DIAGRAM

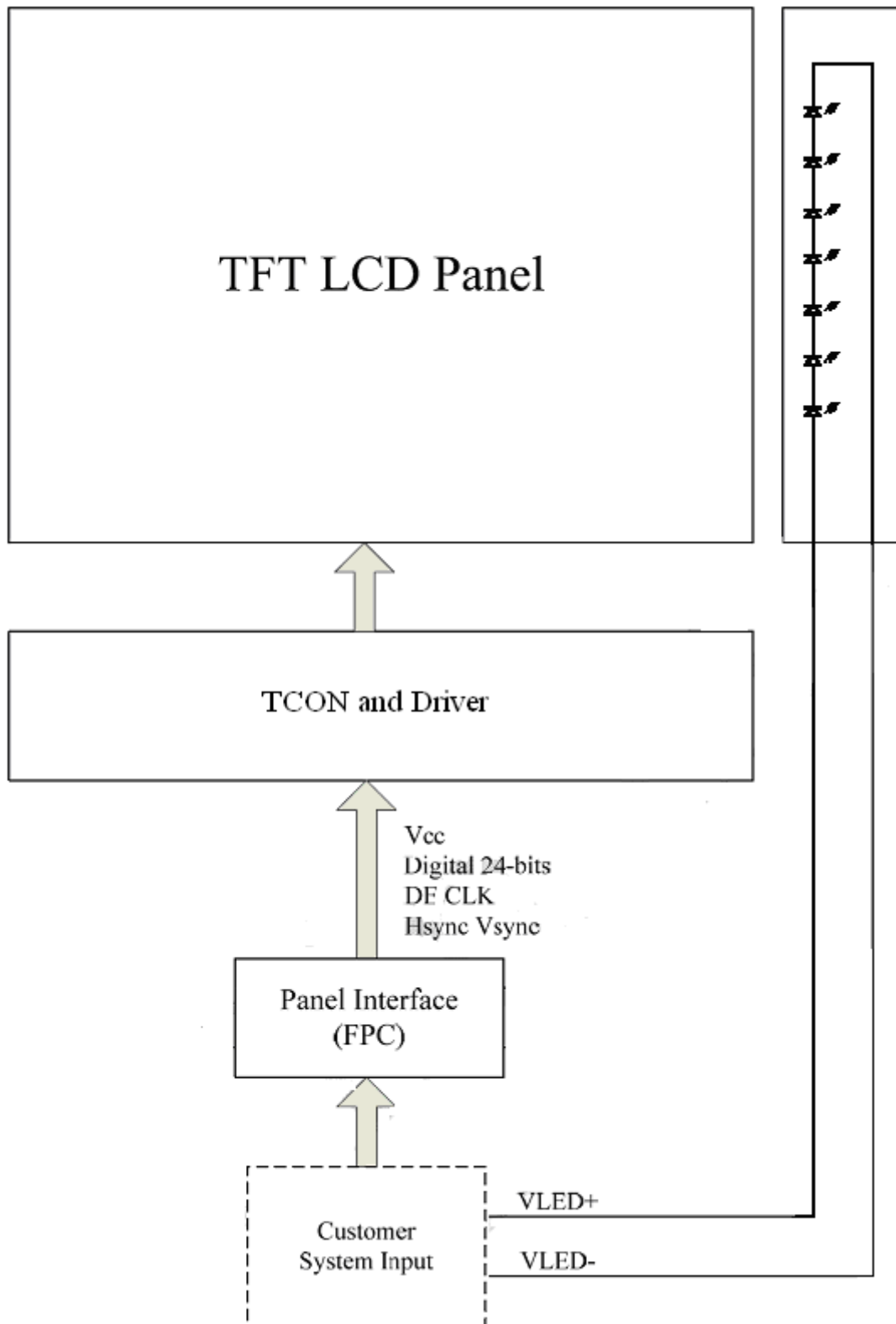

Preliminary

The contents of this document are confidential and must not be disclosed wholly or in part to any third part without the prior written consent of AMPIRE CO., LTD

7. TFT LCD Panel FPC Descriptions

Pin no	Symbol	Function
1	GND	Ground
2	GND	Ground
3	VCC	Power Supply(2.5V~3.6V)
4	VCC	Power Supply(2.5V~3.6V)
5	R0	Red Data Bit 0
6	R1	Red Data Bit 1
7	R2	Red Data Bit 2
8	R3	Red Data Bit 3
9	R4	Red Data Bit 4
10	R5	Red Data Bit 5
11	R6	Red Data Bit 6
12	R7	Red Data Bit 7
13	G0	Green Data Bit 0
14	G1	Green Data Bit 1
15	G2	Green Data Bit 2
16	G3	Green Data Bit 3
17	G4	Green Data Bit 4
18	G5	Green Data Bit 5
19	G6	Green Data Bit 6
20	G7	Green Data Bit 7
21	B0	Blue Data Bit 0
22	B1	Blue Data Bit 1
23	B2	Blue Data Bit 2
24	B3	Blue Data Bit 3
25	B4	Blue Data Bit 4
26	B5	Blue Data Bit 5
27	B6	Blue Data Bit 6
28	B7	Blue Data Bit 7
29	GND	Ground
30	DCLK	Dot Data Clock
31	DISP	Display ON/OFF
32	Hsync	Horizontal Sync Input
33	Vsync	Vertical Sync Input
34	NC	Not Connection
35	NC	Not Connection
36	NC	Not Connection
37	NC	Not Connection
38	Test1	Not Connection
39	Test2	Not Connection
40	Test3	Not Connection

8. INPUT SIGNAL

8.1 Parallel RGB input timing Chart

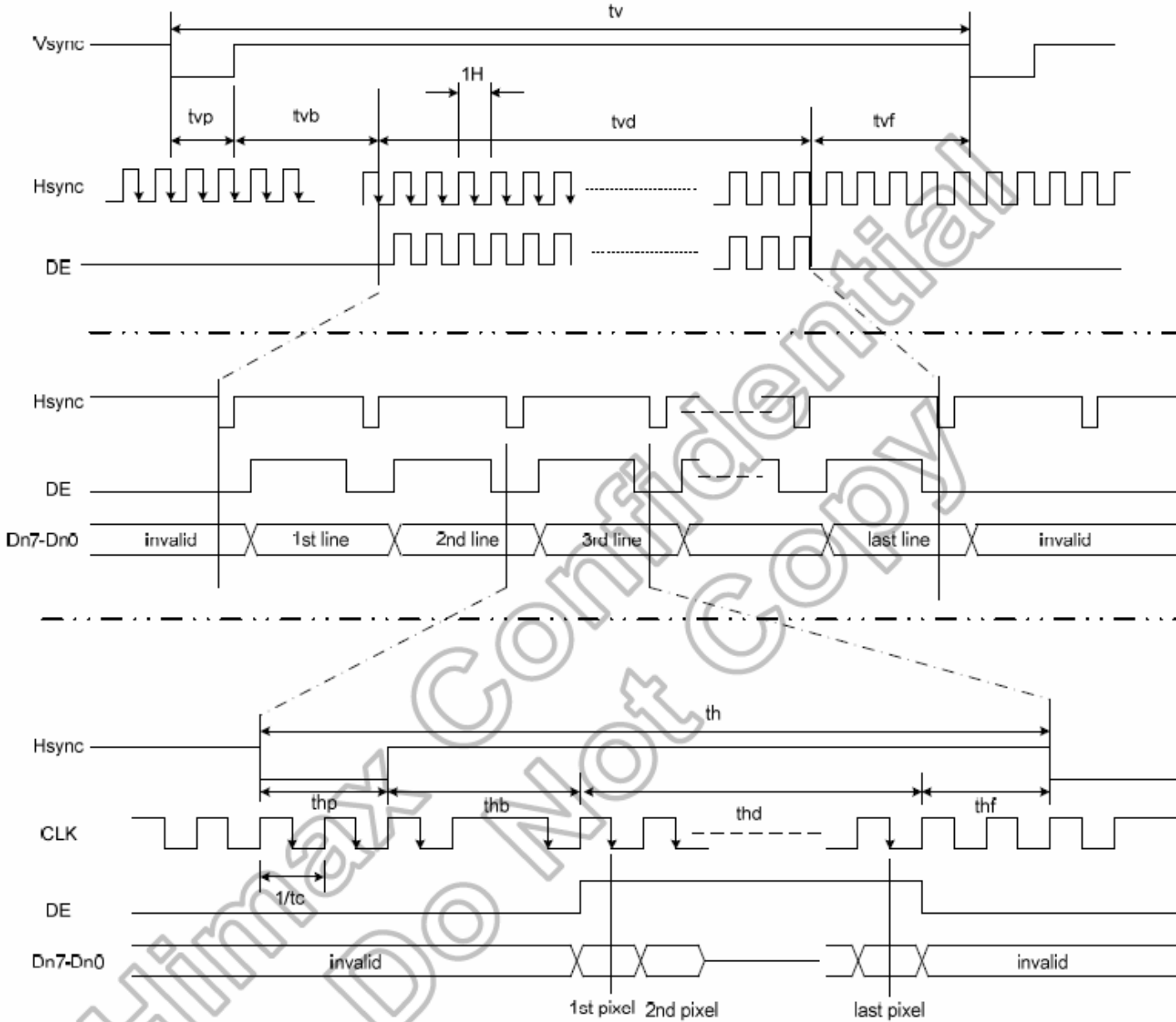

8.2 Timing Specification

Parallel RGB input timing requirement

PARAMETER	Symbol	Min.	Typ.	Max.	Unit
Clock cycle	$1/t_c^{*1}$		9	15	MHz
Hsync cycle	$1/f_H$		17.14	-	KHz
Vsync cycle	$1/f_V$		59.94	-	Hz
Horizontal Signal					
Horizontal cycle	th^2	575	575	605	CLK
Horizontal display period	thd	480	480	480	CLK
Horizontal front porch	thf	2	2	82	CLK
Horizontal pulse width	thp	2	41	41	CLK
Horizontal back porch	thb	2	2	41	CLK
Vertical Signal					
Vertical cycle	tv	285-	286	511	H
Vertical display period	tvd	272	272	272	H
Vertical front porch	tvf	1	2	227	H
Vertical pulse width	tvp	1	10	11	H
Vertical back porch	tvb	1	2	11	H

Note:

1. Unit: CLK=1/ fCLK , H=th
2. Parallel interface. Clock frequency and horizontal signal parameters are tripled in serial interface. The Maximum clock frequency of serial interface is 33MHz
3. thd=480CLK, thf=2CLK, thp=41CLK, thb=2CLK, thf + fhp + ftb > 44

8.3 Timing Chart 2

Input setup timing requirement

PARAMETER	Symbol	Min.	Typ.	Max.	Unit
DISP setup time	t_{diss}	10	-	-	ns
DISP hold time	t_{dish}	10	-	-	ns
Clock period	PW_{CLK}^{*1}	66.7	-	-	ns
Clock pulse high period	PWH^{*1}	26.7	-	-	ns
Clock pulse low period	PWL^{*1}	26.7	-	-	ns
Hsync setup time	t_{hs}	10	-	-	ns
Hsync hold time	t_{hh}	10	-	-	ns
Data setup time	t_{ds}	10	-	-	ns
Data hold time	t_{dh}	10	-	-	ns
DE setup time	t_{des}	10	-	-	ns
DE hold time	t_{deh}	10	-	-	ns
Vsync setup time	t_{vhs}	10	-	-	ns
Vsync hold time	t_{vhh}	10	-	-	ns

Note

1. For parallel interface, maximum clock frequency is 15MHz.
2. tr, tf is defined 10% to 90% of signal amplitude.

8.4 Input setup timing Chart

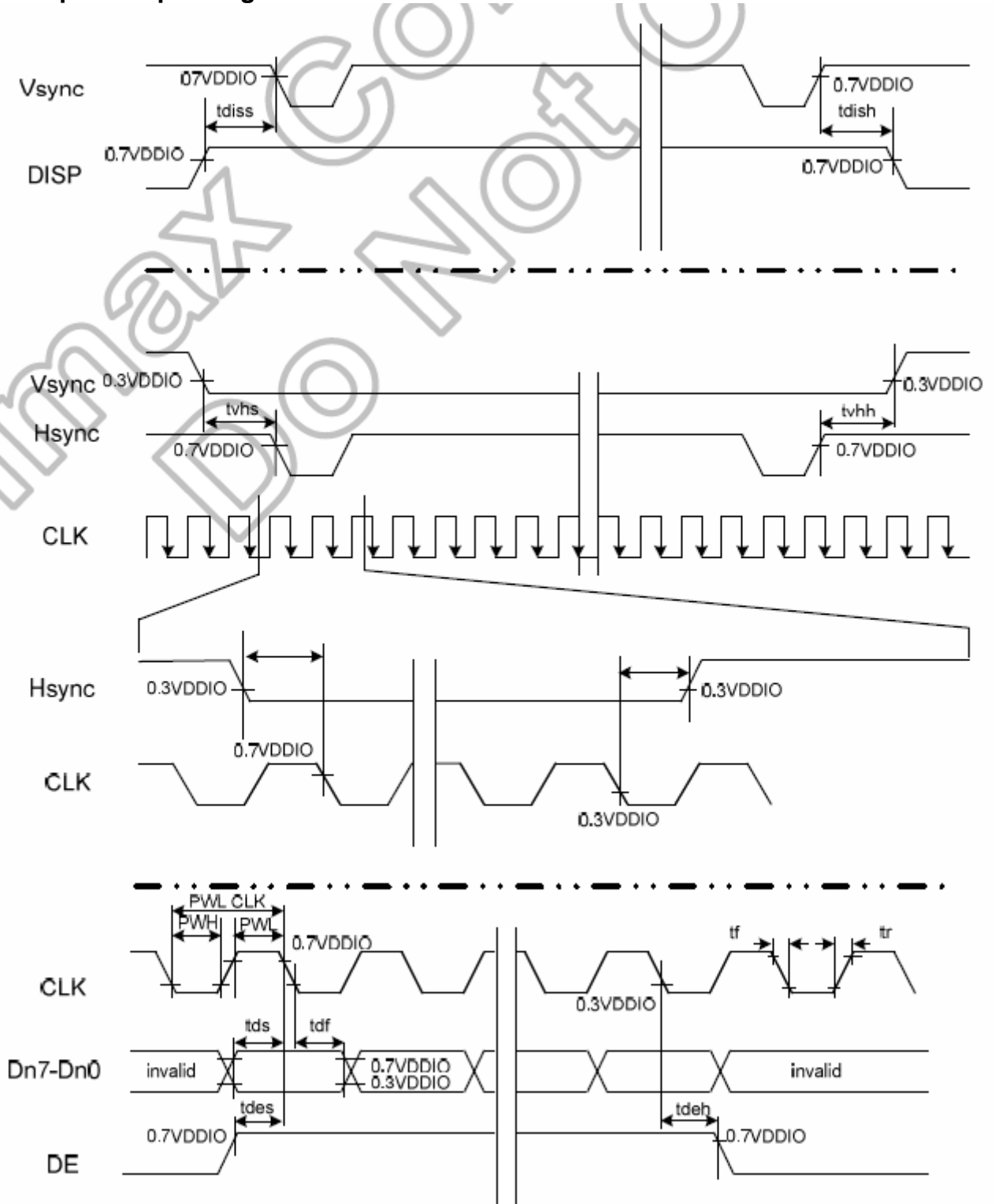

Preliminary

The contents of this document are confidential and must not be disclosed wholly or in part to any third part without the prior written consent of AMPIRE CO., LTD

9. Color Data Assignment

COLOR	INPUT DATA	R DATA								G DATA								B DATA							
		R7	R6	R5	R4	R3	R2	R1	R0	G7	G6	G5	G4	G3	G2	G1	G0	B7	B6	B5	B4	B3	B2	B1	B0
		MSB				LSB				MSB				LSB				MSB				LSB			
BASIC COLOR	BLACK	0	0	0	0	0	0	0	0	0	0	0	0	0	0	0	0	0	0	0	0	0	0	0	0
	RED(255)	1	1	1	1	1	1	1	1	0	0	0	0	0	0	0	0	0	0	0	0	0	0	0	0
	GREEN(255)	0	0	0	0	0	0	0	0	1	1	1	1	1	1	1	1	0	0	0	0	0	0	0	0
	BLUE(255)	0	0	0	0	0	0	0	0	0	0	0	0	0	0	0	0	1	1	1	1	1	1	1	1
	CYAN	0	0	0	0	0	0	0	0	1	1	1	1	1	1	1	1	1	1	1	1	1	1	1	1
	MAGENTA	1	1	1	1	1	1	1	1	0	0	0	0	0	0	0	0	1	1	1	1	1	1	1	1
	YELLOW	1	1	1	1	1	1	1	1	1	1	1	1	1	1	1	1	0	0	0	0	0	0	0	0
	WHITE	1	1	1	1	1	1	1	1	1	1	1	1	1	1	1	1	1	1	1	1	1	1	1	1
RED	RED(0)	0	0	0	0	0	0	0	0	0	0	0	0	0	0	0	0	0	0	0	0	0	0	0	0
	RED(1)	0	0	0	0	0	0	0	1	0	0	0	0	0	0	0	0	0	0	0	0	0	0	0	0
	RED(2)	0	0	0	0	0	0	1	0	0	0	0	0	0	0	0	0	0	0	0	0	0	0	0	0
	RED(254)	1	1	1	1	1	1	1	0	0	0	0	0	0	0	0	0	0	0	0	0	0	0	0	0
	RED(255)	1	1	1	1	1	1	1	1	0	0	0	0	0	0	0	0	0	0	0	0	0	0	0	0
GREEN	GREEN(0)	0	0	0	0	0	0	0	0	0	0	0	0	0	0	0	0	0	0	0	0	0	0	0	0
	GREEN(1)	0	0	0	0	0	0	0	0	0	0	0	0	0	0	1	0	0	0	0	0	0	0	0	0
	GREEN(2)	0	0	0	0	0	0	0	0	0	0	0	0	0	0	1	0	0	0	0	0	0	0	0	0
	GREEN(254)	0	0	0	0	0	0	0	0	1	1	1	1	1	1	1	0	0	0	0	0	0	0	0	0
	GREEN(255)	0	0	0	0	0	0	0	0	1	1	1	1	1	1	1	1	0	0	0	0	0	0	0	0
BLUE	BLUE(0)	0	0	0	0	0	0	0	0	0	0	0	0	0	0	0	0	0	0	0	0	0	0	0	0
	BLUE(1)	0	0	0	0	0	0	0	0	0	0	0	0	0	0	0	0	0	0	0	0	0	0	0	1
	BLUE(2)	0	0	0	0	0	0	0	0	0	0	0	0	0	0	0	0	0	0	0	0	0	0	1	0
	BLUE(254)	0	0	0	0	0	0	0	0	0	0	0	0	0	0	0	0	1	1	1	1	1	1	1	0
	BLUE(255)	0	0	0	0	0	0	0	0	0	0	0	0	0	0	0	0	1	1	1	1	1	1	1	1

Preliminary

The contents of this document are confidential and must not be disclosed wholly or in part to any third part without the prior written consent of AMPIRE CO., LTD

10. QUALITY AND RELIABILITY

10.1 Test Conditions

Tests should be conducted under the following conditions :

Ambient temperature : $25 \pm 5^{\circ}\text{C}$

Humidity : $60 \pm 25\% \text{ RH}$.

10.2 Sampling Plan

Sampling method shall be in accordance with MIL-STD-105E , level II, normal single sampling plan .

10.3 Acceptable Quality Level

A major defect is defined as one that could cause failure to or materially reduce the usability of the unit for its intended purpose. A minor defect is one that does not materially reduce the usability of the unit for its intended purpose or is an infringement from established standards and has no significant bearing on its effective use or operation.

10.4 Appearance

An appearance test should be conducted by human sight at approximately 30 cm distance from the LCD module under florescent light. The inspection area of LCD panel shall be within the range of following limits.

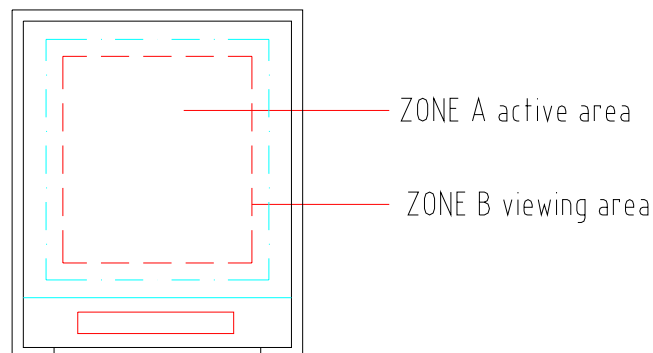

Preliminary

The contents of this document are confidential and must not be disclosed wholly or in part to any third part without the prior written consent of AMPIRE CO., LTD

11. Incoming Inspection Standard

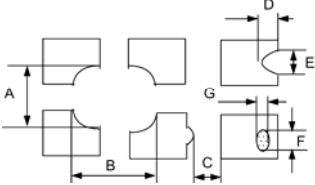
No.	Item	Criterion for defects	Class of Defect	Acceptable level										
1	Non display	No non display is allowed	Major	0.4										
2	Irregular operation	No irregular operation is allowed	Major	0.4										
3	Short	No short are allowed	Major	0.4										
4	Open	Any segments or common patterns that don't activate are rejectable.	Major	0.4										
5	Black/White spot (I)	<table border="1" style="width: 100%;"> <thead> <tr> <th>Size D (mm)</th> <th>Acceptable number</th> </tr> </thead> <tbody> <tr> <td>$D \leq 0.1$</td> <td>Ignore</td> </tr> <tr> <td>$0.1 < D \leq 0.3$</td> <td>4 ※1</td> </tr> <tr> <td>$0.3 < D$</td> <td>0</td> </tr> </tbody> </table> <p>※1: The distance of two defects must be more than 20mm.</p>	Size D (mm)	Acceptable number	$D \leq 0.1$	Ignore	$0.1 < D \leq 0.3$	4 ※1	$0.3 < D$	0	Minor	1.5		
Size D (mm)	Acceptable number													
$D \leq 0.1$	Ignore													
$0.1 < D \leq 0.3$	4 ※1													
$0.3 < D$	0													
6	Dot Defect	<table border="1" style="width: 100%;"> <tbody> <tr> <td>Bright dot</td> <td>$N \leq 2$</td> </tr> <tr> <td>Dark dot</td> <td>$N \leq 4$</td> </tr> <tr> <td>Total dot defect (Bright dot + Dark dot)</td> <td>$N \leq 6$</td> </tr> <tr> <td>Minimum distance between dark dot and dark dot</td> <td>$L \geq 5\text{mm}$</td> </tr> </tbody> </table>	Bright dot	$N \leq 2$	Dark dot	$N \leq 4$	Total dot defect (Bright dot + Dark dot)	$N \leq 6$	Minimum distance between dark dot and dark dot	$L \geq 5\text{mm}$	Minor	1.5		
Bright dot	$N \leq 2$													
Dark dot	$N \leq 4$													
Total dot defect (Bright dot + Dark dot)	$N \leq 6$													
Minimum distance between dark dot and dark dot	$L \geq 5\text{mm}$													
7	Back Light	1. No Lighting is rejectable 2. Flickering and abnormal lighting are rejectable	Major	0.4										
8	Display pattern	 <p style="text-align: center;">Unit:mm</p> <table border="1" style="width: 100%;"> <tbody> <tr> <td>$\frac{A+B}{2} \leq 0.30$</td> <td>$0 < C$</td> <td>$\frac{D+E}{2} \leq 0.25$</td> <td>$\frac{F+G}{2} \leq 0.25$</td> </tr> </tbody> </table> <p>Note: 1. Acceptable up to 3 damages 2. NG if there're to two or more pinholes per dot</p>	$\frac{A+B}{2} \leq 0.30$	$0 < C$	$\frac{D+E}{2} \leq 0.25$	$\frac{F+G}{2} \leq 0.25$	Minor	1.5						
$\frac{A+B}{2} \leq 0.30$	$0 < C$	$\frac{D+E}{2} \leq 0.25$	$\frac{F+G}{2} \leq 0.25$											
9	Blemish & Foreign matters Size: $D = \frac{A+B}{2}$	<table border="1" style="width: 100%;"> <thead> <tr> <th>Size D (mm)</th> <th>Acceptable number</th> </tr> </thead> <tbody> <tr> <td>$D \leq 0.15$</td> <td>Ignore</td> </tr> <tr> <td>$0.15 < D \leq 0.20$</td> <td>3</td> </tr> <tr> <td>$0.20 < D \leq 0.30$</td> <td>2</td> </tr> <tr> <td>$0.30 < D$</td> <td>0</td> </tr> </tbody> </table>	Size D (mm)	Acceptable number	$D \leq 0.15$	Ignore	$0.15 < D \leq 0.20$	3	$0.20 < D \leq 0.30$	2	$0.30 < D$	0	Minor	1.5
Size D (mm)	Acceptable number													
$D \leq 0.15$	Ignore													
$0.15 < D \leq 0.20$	3													
$0.20 < D \leq 0.30$	2													
$0.30 < D$	0													

Preliminary

The contents of this document are confidential and must not be disclosed wholly or in part to any third part without the prior written consent of AMPIRE CO., LTD

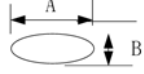
10	Scratch on Polarizer	<table border="1"> <thead> <tr> <th>Width (mm)</th> <th>Length (mm)</th> <th>Acceptable number</th> </tr> </thead> <tbody> <tr> <td>$W \leq 0.05$ and $L \leq 0.3$</td> <td></td> <td>Ignore</td> </tr> <tr> <td>$0.05 < W \leq 0.03$</td> <td>$0.3 < L \leq 2.0$</td> <td>3</td> </tr> </tbody> </table>	Width (mm)	Length (mm)	Acceptable number	$W \leq 0.05$ and $L \leq 0.3$		Ignore	$0.05 < W \leq 0.03$	$0.3 < L \leq 2.0$	3	Minor	1.5
		Width (mm)	Length (mm)	Acceptable number									
$W \leq 0.05$ and $L \leq 0.3$		Ignore											
$0.05 < W \leq 0.03$	$0.3 < L \leq 2.0$	3											
Note: The distance of two defects must be more than 20mm.													
11	Bubble in polarizer 	$D \leq 0.15$ mm, Ignored $0.15 \leq D \leq 0.5$ mm, $N \leq 4$ $D > 0.5$ mm, not allowable $D = (A+B) / 2$	Minor	1.5									
12	Stains on LCD panel surface	Stains that cannot be removed even when wiped lightly with a soft cloth or similar cleaning too are rejectable.	Minor	1.5									
13	Rust in Bezel	Rust which is visible in the bezel is rejectable.	Minor	1.5									
14	Defect of land surface contact (poor soldering)	Evident crevices which is visible are rejectable.	Minor	1.5									
15	Parts mounting	1. Failure to mount parts 2. Parts not in the specifications are mounted 3. Polarity, for example, is reversed	Major Major Major	0.4									
16	Parts alignment	1. LSI, IC lead width is more than 50% beyond pad outline.	Minor	1.5									
		2. Chip component is off center and more than 50% of the leads is off the pad outline.	Minor										
17	Conductive foreign matter (Solder ball, Solder chips)	1. $0.45 < \phi$, $N \geq 1$	Major	0.4									
		2. $0.30 < \phi \leq 0.45$, $N \geq 1$ ϕ : Average diameter of solder ball (unit: mm)	Minor	1.5									
		3. $0.50 < L$, $N \geq 1$ L: Average length of solder chip (unit: mm)	Minor	1.5									
18	Faulty PCB correction	1. Due to PCB copper foil pattern burnout, the pattern is connected, using a jumper wire for repair; 2 or more places are corrected per PCB.	Minor	1.5									
		2. Short circuited part is cut, and no resist coating has been performed.	Minor										
19	mura	ND 6% , See, not allowable	Minor										

Preliminary

The contents of this document are confidential and must not be disclosed wholly or in part to any third part without the prior written consent of AMPIRE CO., LTD

[Note1] W : Width[mm], L : Length[mm], N : Number, ϕ : Average Diameter

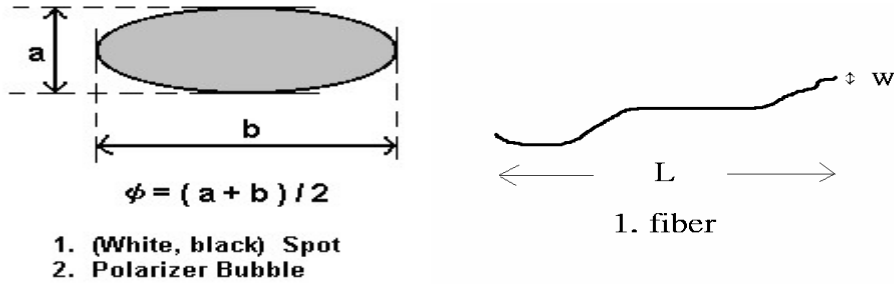

[Note2] Bright dot is defined through 6% transmission ND Filter as following.

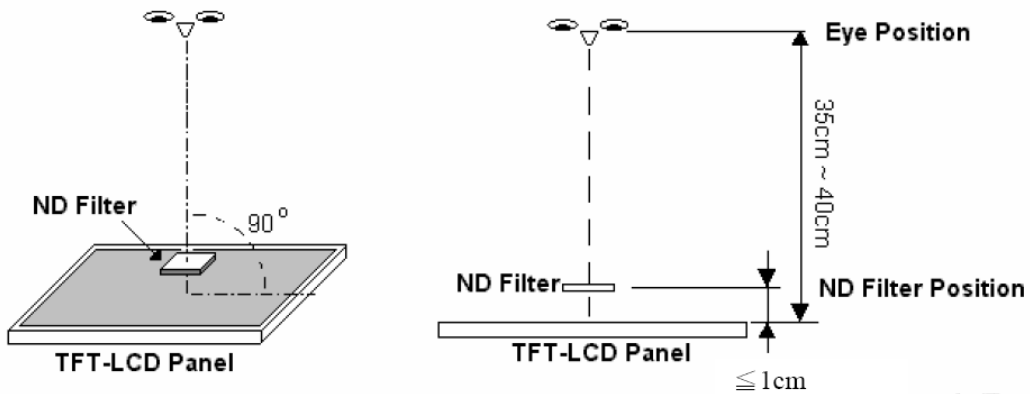

[Note3]

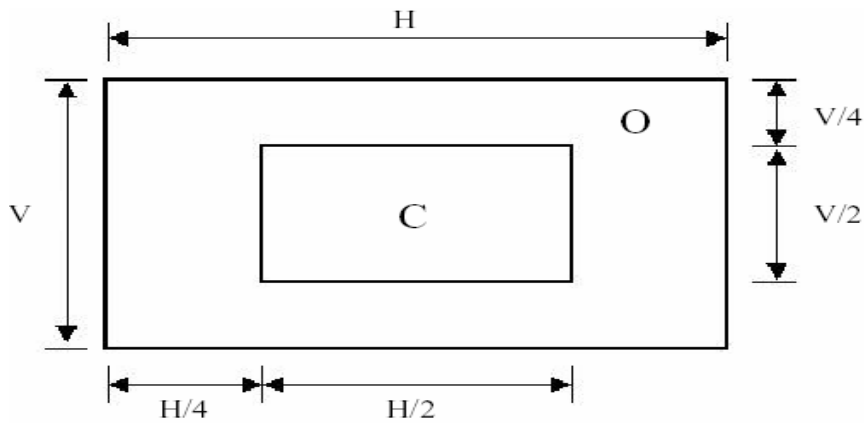

C Area: Center of display area
C Area: Outer of display area

[Note4]

Judge defect dot and adjacent dot as following. Allow below (as A, B, C and D status) adjacent defect dots, including bright and dart adjacent dot. And they will be counted 2 defect dots in total quantity.

Preliminary

The contents of this document are confidential and must not be disclosed wholly or in part to any third part without the prior written consent of AMPIRE CO., LTD

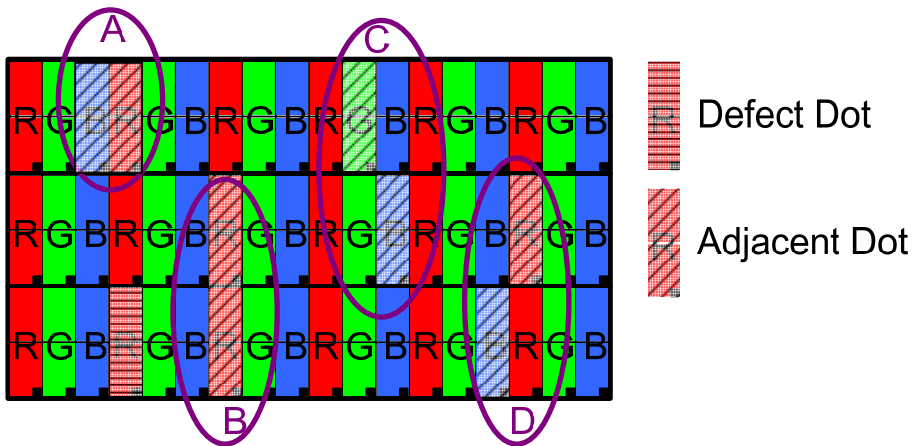

- (1) The defects that are not defined above and considered to be problem shall be reviewed and discussed by both parties.
- (2) Defects on the Black Matrix, out of Display area, are not considered as a defect or counted.

Preliminary

The contents of this document are confidential and must not be disclosed wholly or in part to any third part without the prior written consent of AMPIRE CO., LTD

12. Reliability Test

Test Item	Test Conditions	Note
High Temperature Operation	70±3°C , t=96 hrs	
Low Temperature Operation	-20±3°C , t=96 hrs	
High Temperature Storage	80±3°C , t=96 hrs	1,2
Low Temperature Storage	-30±3°C , t=96 hrs	1,2
Thermal Shock Test	-30°C ~ 25°C ~ 80°C 30 m in. 5 min. 30 min. (1 cycle) Total 5 cycle	1,2
Humidity Test	40 °C, Humidity 90%, 96 hrs	1,2
Vibration Test (Packing)	Sweep frequency : 10 ~ 55 ~ 10 Hz/1min Amplitude : 0.75mm Test direction : X.Y.Z/3 axis Duration : 30min/each axis	2

Note 1 : Condensation of water is not permitted on the module.

Note 2 : The module should be inspected after 1 hour storage in normal conditions (15-35°C , 45-65%RH).

Definitions of life end point :

- Current drain should be smaller than the specific value.
- Function of the module should be maintained.
- Appearance and display quality should not have degraded noticeably.
- Contrast ratio should be greater than 50% of the initial value.

13. USE PRECAUTIONS

13.1 Handling precautions

- 1) The polarizing plate may break easily so be careful when handling it. Do not touch, press or rub it with a hard-material tool like tweezers.
- 2) Do not touch the polarizing plate surface with bare hands so as not to make it dirty. If the surface or other related part of the polarizing plate is dirty, soak a soft cotton cloth or chamois leather in benzene and wipe off with it. Do not use chemical liquids such as acetone, toluene and isopropyl alcohol. Failure to do so may bring chemical reaction phenomena and deteriorations.
- 3) Remove any spit or water immediately. If it is left for hours, the suffered part may deform or decolorize.
- 4) If the LCD element breaks and any LC stuff leaks, do not suck or lick it. Also if LC stuff is stuck on your skin or clothing, wash thoroughly with soap and water immediately.

13.2 Installing precautions

- 1) The PCB has many ICs that may be damaged easily by static electricity. To prevent breaking by static electricity from the human body and clothing, earth the human body properly using the high resistance and discharge static electricity during the operation. In this case, however, the resistance value should be approx. 1M Ω and the resistance should be placed near the human body rather than the ground surface. When the indoor space is dry, static electricity may occur easily so be careful. We recommend the indoor space should be kept with humidity of 60% or more. When a soldering iron or other similar tool is used for assembly, be sure to earth it.
- 2) When installing the module and ICs, do not bend or twist them. Failure to do so may crack LC element and cause circuit failure.
- 3) To protect LC element, especially polarizing plate, use a transparent protective plate (e.g., acrylic plate, glass etc) for the product case.
- 4) Do not use an adhesive like a both-side adhesive tape to make LCD surface (polarizing plate) and product case stick together. Failure to do so may cause the polarizing plate to peel off.

13.3 Storage precautions

- 1) Avoid a high temperature and humidity area. Keep the temperature between 0°C and 35°C and also the humidity under 60%.
- 2) Choose the dark spaces where the product is not exposed to direct sunlight or fluorescent light.
- 3) Store the products as they are put in the boxes provided from us or in the same conditions as we recommend.

13.4 Operating precautions

- 1) Do not boost the applied drive voltage abnormally. Failure to do so may break ICs. When applying power voltage, check the electrical features beforehand and be careful. Always turn off the power to the LC module controller before removing or inserting the LC module input connector. If the input connector is removed or inserted while the power is turned on, the LC module internal circuit may break.
- 2) The display response may be late if the operating temperature is under the normal standard, and the display may be out of order if it is above the normal standard. But this is not a failure; this will be restored if it is within the normal standard.
- 3) The LCD contrast varies depending on the visual angle, ambient temperature, power voltage etc. Obtain the optimum contrast by adjusting the LC drive voltage.
- 4) When carrying out the test, do not take the module out of the low-temperature space suddenly. Failure to do so will cause the module condensing, leading to malfunctions.
- 5) Make certain that each signal noise level is within the standard (L level: 0.2V_{dd} or less and H level: 0.8V_{dd} or more) even if the module has functioned properly. If it is beyond the standard, the module may often malfunction. In addition, always connect the module when making noise level measurements.
- 6) The CMOS ICs are incorporated in the module and the pull-up and pull-down function is not adopted for the input so avoid putting the input signal open while the power is ON.
- 7) The characteristic of the semiconductor element changes when it is exposed to light emissions, therefore ICs on the LCD may malfunction if they receive light emissions. To prevent these malfunctions, design and assemble ICs so that they are shielded from light emissions.
- 8) Crosstalk occurs because of characteristics of the LCD. In general, crosstalk occurs when the regularized display is maintained. Also, crosstalk is affected by the LC drive voltage. Design the contents of the display, considering crosstalk.

13.5 Other

- 1) Do not disassemble or take the LC module into pieces. The LC modules once disassembled or taken into pieces are not the guarantee articles.
- 2) The residual image may exist if the same display pattern is shown for hours. This residual image, however, disappears when another display pattern is shown or the drive is interrupted and left for a while. But this is not a problem on reliability.
- 3) AMIPRE will provide one year warrantee for all products and three months warrantee for all repairing products.

Preliminary

The contents of this document are confidential and must not be disclosed wholly or in part to any third part without the prior written consent of AMPIRE CO., LTD

REV	REVISION RECORD	DATE (MM)	NAME
0	NEW RELEASE	04-20-09	SNOW
1	Added Stiffener (25.0x22.4x0.3T)	11-06-09	SNOW

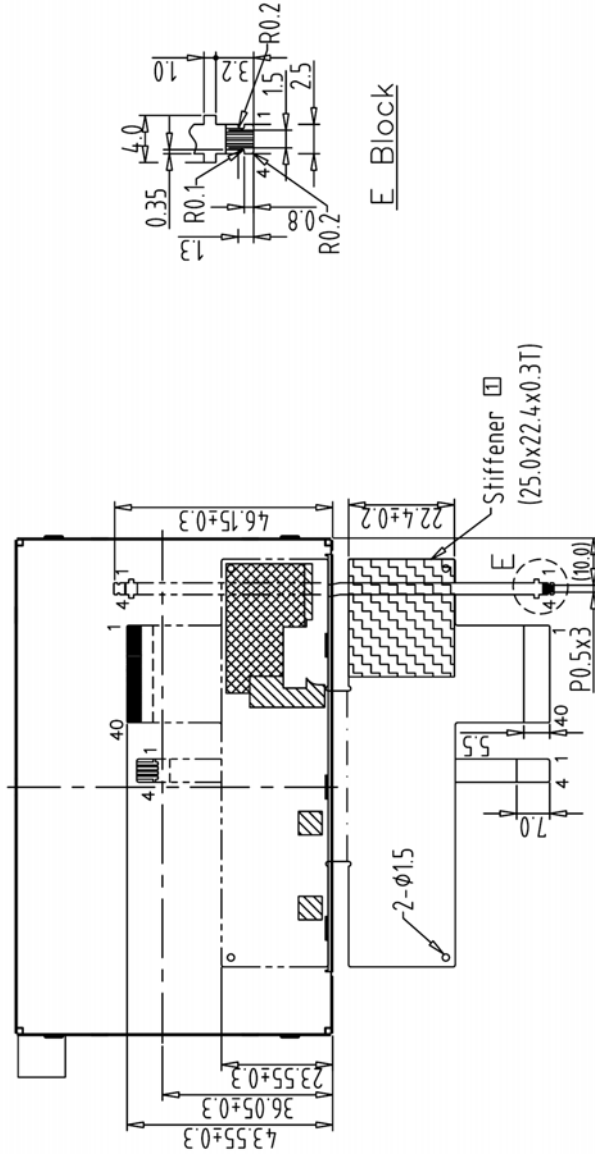

LED	CA(-)	NC	NC	AN(+)
1				
2				
3				
4				

Back view

- Note:
1. Unless indicated, Tolerance Grade "B" is adopted.
 2. UV Glue For OLB Protection.
 3. LCD 480x272 (R.G.B) TFT LCD =>480272H 4.3" TFT LCD

NO.	480272H2+480272C1	T/P	TOLERANCE GRADE(±)	A	B	DIM.	MM	DWN.	SNOW	DATE	DATE	TITLE
7			~6	0.05	0.1					04-20-09		480272H2-T
8			6~18	0.08	0.18	IF NO.		CHK.				(4.3")
9			18~50	0.1	0.25	PARTS NO. LCM-1		APPD.				
10			50~180	0.2	0.4	480272H2-T						
11			180~	0.3	0.5							
12												

AMPIRE 晶采光电科技

DWG. NO. *O90427MB

SHEET 1 OF 1