

Application Notes

Relays

Electromechanical Relays

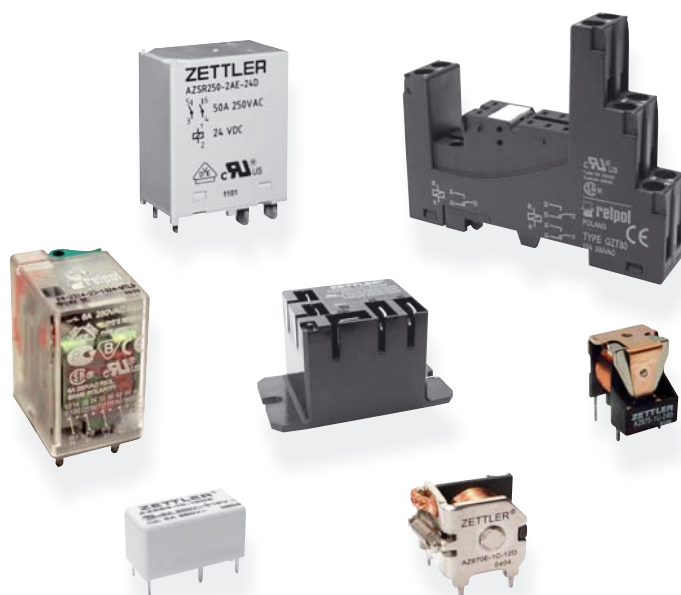

Air distance

→ Clearance

All-or-nothing relay

Electrical relay whose → input energizing quantity is either within the operative range or zero; → wave form of coil energization.

Ambient temperature (in use)

Temperature, measured directly near the relay. The maximum allowed value may not be exceeded, otherwise there is the danger of lasting damage (e.g. reduced contact force or overheating of the energized coil).

Ambient temperature (storage and transport)

The maximum allowed value may not be exceeded, otherwise there is the danger of lasting damage.

Application guidelines

Very different loads (e.g. high load and measuring signal) shall not be switched by the same relay. → Contact erosion from switching high loads may pollute the low level switching contacts.

The actual contact load shall not be lower than the specified → minimum contact load.

Some adhesive pastes, insulating tubes, conformal coatings, heat conducting pastes, rubber contacts, greases or oils contain silicone based compounds. Due to outgassing or creepage of the silicones they may accumulate on the contacts, these residues are burnt by the → arc and form high-resistive layers on the contact surface. We strongly recommend avoiding any kind of silicon near the relays.

The → input energizing quantity has to be applied to the coil in rectangular wave form; → wave form of signal.

Open relays (relays without any cover; → case sealing) have no protection against touch, corrosive influence or foreign particles. Thus they should be used in a housing, which guarantees the necessary protection.

The → input energizing quantity has to be applied to the coil in random mode with respect to the point on the AC-wave → phase synchronization.

Use of the relay at very high ambient humidity may cause corrosion of the metal parts.

Very low ambient atmospheric pressure (high altitude) reduces the applicable dielectric test voltage.

If sealed relays switch heavy loads at high switching rates, increased → electrical endurance can be achieved by → venting the relay. However, corrosive gases from the ambient atmosphere may penetrate into a vented relay; this can negatively influence the reliability of a relay.

Switching high loads creates arcs; these arcs may not extinguish before the movable contact of a → change-over relay touches the opposite contact. The intrinsically insulated outer contacts are then connected by the arc; this leads to short circuits (e.g. in the applications shown below). This problem can be avoided by using a separate relay which interrupts the circuit before the change-over relay switches and which closes the circuit afterwards.

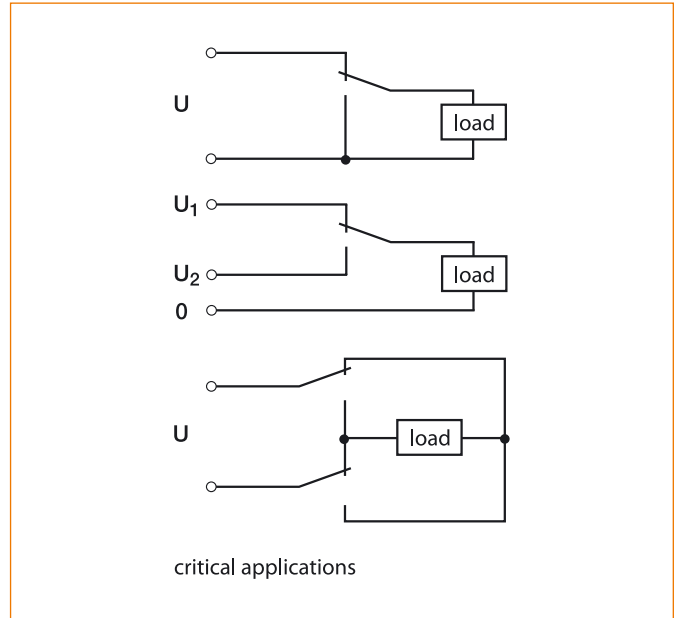

Inflammable gases in the ambient atmosphere may be ignited by the arc at the relay contacts. Even with sealed relays, the case seal does not prevent the penetration of combustible gases into the relay.

Strong external magnetic fields (e.g. from other neighbouring polarized relays or permanent magnets) may influence the → operate and release values.

For all PCB we strongly recommend a suitable cross section of the tracks to avoid overheating.

Before using relays in environments with shocks and vibrations we recommend to contact the supplier to get information for the optimal mounting direction.

Before approve any component for a mass-production, we strongly recommend to test these products under a situation close to the final production situation to ensure a trouble-free production process and subsequent product function. The decision on the suitability of the product is the solely liability of the customer. The operation beyond the specification of our products carries the risk of dangerous conditions.

To prevent such dangerous conditions the customer has to perform reasonable measures. All our product data are shown in the specifications are designated for users with expertise and experience in implementation of these technical data.

The customer has to make sure that the product is in compliance with existing regulations and relevant standards which valid for the application.

If neighbouring contact sets within the same relay switch essentially different voltages and arcs at the contacts occur, a short circuit between the sets by the arc cannot be excluded. A clarifying discussion with the relay supplier is recommended. Countermeasures are:

- Another circuit layout which avoids very different voltages between the contact sets.
- To provide for a non-used contact set between the vital contacts.
- The use of a relay which offers a very good insulation between the contact sets.
- The use of two or more single relays.

Examples of critical applications are shown below.

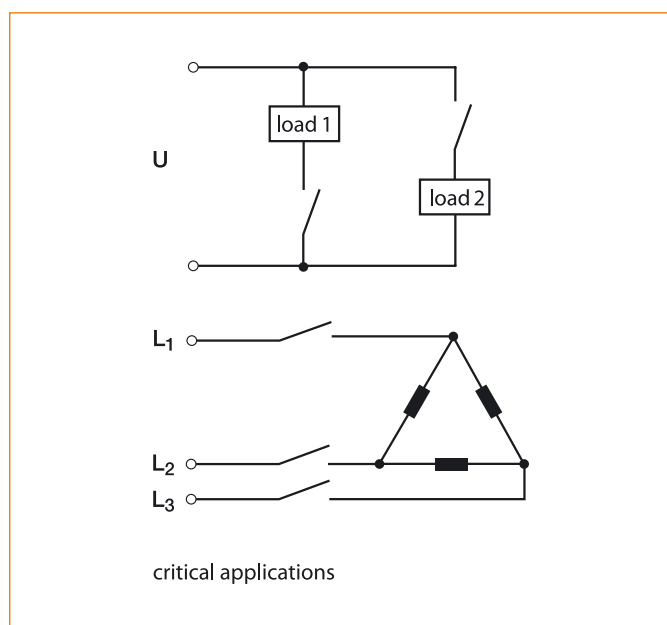

Approvals

Several different test and approval authorities test relays according to national or international standards. Approved parameters, such as contact load (voltage, current, load type), ambient temperature or life expectancy are probably lower than the limits of the relay. When the tests are passed, the manufacturer is allowed to mark the relay or the packing with an approval mark. Important approvals are:

VDE	Germany
UL	USA
CUR	USA, approval valid also in Canada
CSA	Canada
SEV	Switzerland
DEMKO	Denmark

NEMKO	Norway
SEMKO	Sweden
SETI	Finland
TÜV	Germany

Arc

Even at low voltages and currents of less than 100 mA, electrical discharge effects occur at opening and closing of contacts. At higher values (e.g. from 12 V / 0.4 A at Ag contacts) thermal arcs may occur; a current is still flowing although the contact has already opened. If the contact gap is big enough, the arc extinguishes.

The maximum allowed DC values at which the arc still extinguishes, are often published in relay data sheets as a load limit curve or a table of voltage against current. If those values are exceeded, a long burning arc will occur which then rapidly leads to a relay defect or destruction.

When AC loads are switched off, the arc extinguishes at the next zero crossing of the sine wave of the switching voltage or current. Thus a much higher power can be switched than with DC loads.

Bifurcated contact

Each contact spring carries two contacts which work in parallel, but which are mechanically almost independent. The contact reliability at low contact load is increased. At high loads a → single contact is usually an advantage.

Bistable relay

An electrical relay which stays in a predetermined contact position after removal of the coil energization. For return to initial condition another suitable energizing pulse is necessary (e.g. pulse to the reset coil). Due to mechanical shocks or vibration during shipping the relay may change its switching position. Therefore we can't guarantee a defined switching position at delivery. We recommend a defined RESET before starting the application.

Bounce time

Time interval between the first and the final closing (or opening) of a contact, caused by a mechanical shock process in contact movement. These shock processes are called contact bounce. Values shown in datasheets are measured at rated voltage and reference temperature.

Break contact

The contact is closed when the relay is in the off condition and open when the relay is in the on condition; → contact assembly.

Bridge contact

Special → contact assembly; two stationary contacts are connected by a movable bridge. In open contact condition the bridge is separated on both its sides from the stationary contacts. Due to this double interruption a bigger → contact gap can be achieved; this is of advantage especially at very high contact loads or when there are safety requirements.

Capacitance

Insulated metal parts of the relay form a capacitor; its capacitance is measured in pF. It is an important value for high frequency applications.

Categories of protection (IEC 61810)

- RT 0:** Unenclosed relay
Relay not provided with a protective case.
- RT I:** Dust protected relay
Relay provided with a case which protects its mechanism from dust.
- RT II:** Flux proof relay
Relay capable of being automatically soldered without allowing the migration of solder fluxes beyond the intended areas.
- RT III:** Wash tight relay
Relay capable of being automatically soldered and subsequently undergoing a washings process to remove flux residues without allowing the ingress of flux or washing solvents.
- Note: In service, this type of relay is sometimes vented to the atmosphere after soldering or washing process; in this case the requirements with respect to clearances and cree page distances can change.
- RT IV:** Sealed relay
Relay provided with a case which has no venting to the outside atmosphere, and having a time constant better than 2×10^4 s in accordance with IEC60068-2-17.
- RT V:** Hermetically sealed relay
Sealed relay having an enhanced level of sealing, assuring a time constant better than 2×10^6 s in accordance with IEC60068-2-17.

Change-over contact

Combination of the two contact forms, break- and make contact, using one common contact spring. When one contact circuit is open, the other one is closed; → contact assembly

In case of an arc, N.O. and N.C. contact can temporarily be connected.

Cleaning of PCBs

→ Handling guidelines

Clearance (air distance)

Closest distance through air between two conductive parts.

Coil configuration

→ Driver protection circuit

Coil current

DC coils: Calculation from the applied voltage and actual coil resistance according to Ohm's law.

AC coils: The coil current is much lower than expected from the resistive DC resistance, thus the current is often specified in the data sheets. At the moment of switching the coil on, the current is higher than in continuous use.

Coil resistance

DC resistance of a relay coil at reference temperature (+20 °C). Higher coil temperatures increase the resistance value by 0.4 % per Kelvin (0.4 % per °C); e.g. at 40 °C the coil resistance is increased by 8 %. Thus the coil voltage has to be adapted accordingly (→ operate value). With AC coils, the impedance is much higher than the DC resistance, so, often the coil current at nominal coil energization is published additionally.

Coil temperature (maximum)

The temperature of the relay coil depends on the → ambient temperature, the power in the coil (→ temperature rise) and warming due to contact current. The coil temperature may not exceed the maximum allowed value. If relays are placed side by side they may warm each other up.

Contact application class

According to their switching load, in standards IEC 225-23, DIN IEC 225 part 7 and VDE 0435 contacts are divided in 4 classes; → contact resistance

Contact arrangement

→ Contact assembly

Contact assembly (contact form)

The three most important versions are → make contact, → break contact and → change-over contact. Often they are abbreviated as follows:

English	American	German
make	Form A SPST-NO (normally open)	1
break	Form B SPST-NC (normally closed)	2
change over	Form C SPDT	21

double make Form U SPST NO DM

double break Form V SPST NC DB

double break,

double make Form W SPST NC-NO DB-DM

The following circuit diagrams show important contact assemblies in a deenergized relay (initial position):

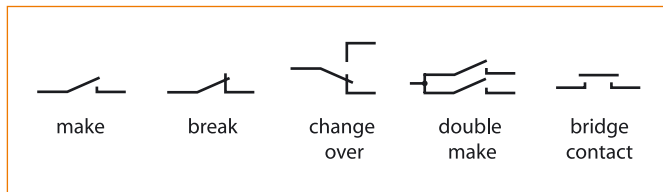

Contact erosion

During the switching of intermediate and high loads contact material evaporates in the → arc and forms powdery layers on contact surfaces and neighbouring surroundings. The resulting material loss limits the → electrical endurance.

Contact force

The force with which two contacts press against each other during a closed contact circuit. With → break contacts of non-polarized relays the contact force is achieved by the spring tension of the contact springs. → Make contacts are pressed against each other by the force of the magnetic circuit; contact forces and thus → vibration resistance and → shock resistance are usually higher.

Contact gap

Distance between the contacts in the open contact circuit condition.

Contact material

The choice of the optimum contact material is of the utmost importance for reliable contact function, whereby the possible application range is also dependant on the type of relay. The following list is just a selection of widely used contact materials; it can only show a rough indication. More precise information is contained in the data sheet for the respective relay type; in case of doubt, a discussion with the relay supplier is recommended.

Gold (Au)

- highly corrosion resistant, most important material for reliable switching of low contact loads
- due to high cost gold is often used in the form of a layer on the contact surface
- a layer free of pores, useful for low loads, should have a thickness of at least 3 μm
- gold flash (typ. 0.2 μm thickness) is mainly used for storage purpose only

- due to a danger of contact welding, unfavourable at high loads.

Silver-Palladium (AgPd), typically 30...60 % Pd

- for medium loads; if gold plated, for low loads also
- corrosion resistant especially against sulphur gases
- low → net metal transfer
- often used in telecom applications.

Silver (Ag) in pure condition or with a low amount of additives (e.g. 0.15 % Ni)

- good for medium loads
- less useful for high AC-loads and high inrush currents.

Hardsilver (AgCu), typically 3 % Cu

- good for medium loads
- less useful for high AC-loads and high inrush currents
- less → contact erosion than Ag.

Silver-Nickel (AgNi), typically 10 % Ni

- for medium and higher switching loads
- better resistance against → contact erosion and welding than AgCu.

Silver Cadmium Oxide (AgCdO), typically 10 % CdO

- for high switching loads, especially for mains applications
- low tendency for contact welding, good resistance against contact erosion
- less useful for lower loads.

Silver Tin Oxide (AgSnO₂), typically 10 % SnO₂

- for high switching loads, especially for mains applications, also at high inrush currents
- very low tendency for contact welding, good resistance against → contact erosion
- at resistive loads lower → electrical endurance than AgCdO
- less useful for lower loads.

Tungsten (W)

- especially for high inrush currents
- mainly used as pre-make contact

Contact protection circuit

Electrical device to reduce inductive voltage at switching off of inductive loads like magnets, conductors or relays; → driver protection circuit.

Contact resistance

Electrical resistance of a closed contact circuit, measured at the terminals of the relay. Depending on contact application class (standard IEC 255, part 7) different values of measuring voltage and current are defined:

Application class	Contact load in application	Typical load for CR measurement
0	0...30 mV / 0...10 mA	30 mV / 10 mA
1	30 mV...60 V / 10...100 mA	100 mV / 10 mA
2	5...250 V / 0,1...1 A	24 V / 100 mA
3	5...600 V / 0,1...100 A	24 V / 1 A

Continuous current (contacts)

Maximum value of current (RMS-value at AC), which a previously closed contact can continuously carry under defined conditions.

Continuous duty

Application mode, in which the relay is at least energized for such a long time that thermal equilibrium is reached.

Creepage distance

Closest distance between two conductive parts, measured along the surface of insulated parts.

Degree of protection, IP-code

The first number characterizes the protection against foreign particles and touch, the second the protection against penetrating water.

With most relays the connecting terminals are not protected, the complete relay has IP 00. With regard to the case sealing the following is valid:

- open relay: IP 00, no protection against touch or water
- dust proof relay: IP 40, protected against coarse dust and touch by a test wire, no water protection
- sealed relay: IP 67, totally sealed against dust and touch by a test wire, protection for part time immersion in water.

Dielectric test voltage (dielectric strength)

RMS value of the AC voltage, which is applied for test purpose between insulated metal parts of a relay. The higher the applicable test voltage, the better the separation e.g. between input circuit and contact circuit. Other test method: → impulse voltage test.

Double break contact

Compound contact which consists of two simultaneously working → break contacts; they have a common contact spring. This contact form is used in some automotive relays. Designation in the U.S.: Form V.

Double make contact

Compound contact which consists of two simultaneously working → make contacts; they have a common contact spring. This contact form is used in some automotive relays. Designation in the U.S.: Form U.

Double break, double make contact

Compound contact which consists of two simultaneously working → change over contacts; they have a common contact spring. This contact form is used in some automotive relays. Designation in the U.S.: Form W.

Driver protection circuit

When the coil energization is switched off, a very high negative peak voltage is produced by the coil and it may reach more than 10...20 times the nominal coil voltage. Possible destruction of the switching semiconductor (driver) in the coil circuit is the result. A solution is provided by a so called driver protection circuit, that is a damping component which is connected in parallel to the coil. It protects the driver but does slow the release time of the relay.

Commonly used driver protection circuits are shown in table Coil Driver Protection Circuits.

(to) Drop out

→ Release

Duty factor (duty cycle)

The ratio (in %) between on-time and sum of on- plus off-time at periodic energization of the relay coil.

Electrical endurance (contact performance)

Number of operations until switching failure of a relay under defined conditions of load and of ambient influences. The life figures are mostly valid for the maximum specified resistive load.

At lower contact loads a substantially longer electrical life is achieved.

At higher loads the electrical life is reduced substantially.

If inductive AC-load has to be switched, the life depends on power factor $\cos \phi$.

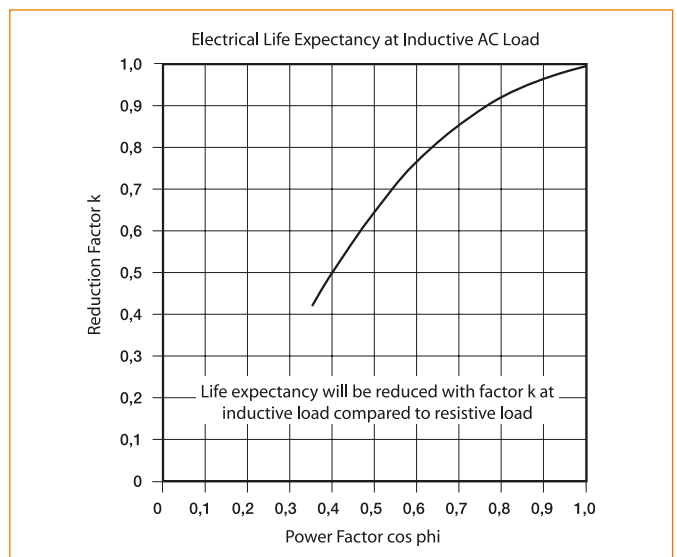

	Resistor	Diode	Zener Diode	Varistor	CR Circuit
Selecting advice	$2...6 \times R_{\text{coil}}$	reverse breakdown voltage much higher than coil voltage of relay, forward current at least equal coil current	zener voltage: $2...3 \times V_{\text{coil}}$	characteristic voltage higher than max. voltage at relay coil	resistor R about coil resistance of relay, capacitor to be investigated by experiment, about 1...100 nF
Peak voltage at relay	$2...6 \times V_{\text{coil}}$	about 0.7 V	zener voltage	depending on characteristic line of varistor	depending on chosen R and C value (measure with storage scope)
Change of release time	high	very high	low	low	depending on chosen R and C value
Application	DC and AC	DC only	DC, if two zener diodes are connected reversely in series, for AC also	DC and AC	DC and AC
Remark	steady current flowing when relay is operated	due to a very slow release, enlarged burning time of arcs at high contact load; reduced electrical endurance; not recommended at high loads and high life requirements	additional diode necessary (in series to zener diode) most recommended coil configuration	relatively expensive	optimum values of R and C have to be investigated by experiment

Coil Driver Protection Circuits

Unless otherwise noted the specified electrical endurance refers to:

- NO contact
- Resistive load
- Rated coil voltage
- Ambient temperature 20 °C
- Category of protection flux proof – RT II

As most applications are not resistive but complex, it is highly recommended to measure the detailed load conditions and to run an additional life test under original conditions.

Electrical relay

Component which creates sudden predetermined changes in one or several output circuits if determined conditions in the electrical input circuit are fulfilled.

Electromechanical relay

An → electrical relay in which the designed response in the output circuit is created by the relative movement of mechanical elements under the action of a current in the input circuit.

Flammability (UL 94)

A flammability class (V-0 / V-1 / V-2 / HB) for plastics is defined in the American specification UL 94; V-0 is the best class. Duration of burning, duration of glowing and burning drops are the parameters for judgement.

Gold plating, gold clad

→ Contact material

Handling guidelines

Electromechanical relays are components which have to be handled with some care:

- To touch the terminals with fingers may lead to poor solderability, especially if the solder process occurs at a later date.
- The PCB layout and the diameters of drilling holes have to be considered; the relay pins may not be bent; serious mechanical side forces may for instance reduce the adjustment values of the contact springs.
- Extreme mechanical shocks, e.g. caused by dropping of a relay, may not only bend the pins, but can result in lasting damage of the relay, e.g. breaking of plastic parts or reduction of → contact force. Such a mechanical strain has to be absolutely avoided. Please note: even when a relay falls onto a hard floor from a height of 'only' 50 cm, decelerations of some hundred g's (e.g. 300 times the gravitational acceleration) are exerted on the relay!

The amount of flux for the soldering process should be as small as possible. The flux may not flow over the top side of the PCB unless sealed relays are used.

Solder temperature and time have to be kept within the limit specified in the data sheet. Common limits are max 270 °C and maximum of 5 seconds. The compatibility of the cleaning liquid and the washing process has to be checked by the user. Cleaning of soldered PCBs in a liquid medium is allowed only, if sealed relays are used. The corresponding information on the data sheet must be met.

To avoid failures or damaging of relays due to ultrasonic clearing, it is necessary to test the clearing process under original cleaning conditions. Under certain conditions ultrasonic clearing can damage the relays.

During ultrasonic cleaning of soldered PCBs, a so called 'cold welding' of gold plated → break contacts (adhesion of the gold layers due to intensive friction movements) may happen. Such relays should not be ultrasonically cleaned.

Soldered PCBs may be conformally coated only if sealed relays are used. In case coating is necessary we recommend to contact the relay supplier. We strongly recommend avoiding any kind of silicon near the relays.

Hold value

→ Non-release value

Impulse voltage test

Between insulated metal parts a short voltage pulse is applied which may not cause a flash over. Example for such a pulse: peak voltage 2500 V; rise time 1.2 μs, decay time 50 μs.

Input energizing quantity

Electrical quantity, usually voltage, which has to be applied to the coil of an electrical relay under determined conditions to attain the expected function.

Inrush current

→ Limiting making current

Insulation group

Definition according to older standard VDE 0110; the classification is made according to influence of ambient, of overvoltage, and of nominal voltage of insulation. 5 groups from A0 (no influence) to D (very strong influence) are specified. Declaration: e.g. insulation group C at 250 VAC / 300 VDC. In the actual standard IEC 664-1 / VDE 0110 → pollution degrees are defined.

Insulation resistance

Electrical resistance, measured between insulated relay parts at a test voltage of 500 VDC.

Latching relay

→ Bistable relay

LED indicator parallel to the coil

LED in a relay (often in industrial relays) which indicates that a voltage is applied to the coil. Contrary to the → mechanical indicator, the LED does not always show the switching status of the contacts, e.g. when the voltage at the coil is lower

than the → operate voltage. The polarity of the coil has to be considered.

Lightning surge test

→ Impulse voltage test

Limiting continuous thermal withstand value

Highest value of the → input energizing quantity (mostly coil voltage) which may be applied at → continuous duty depending on → ambient temperature without exceeding the maximum → coil temperature.

Limiting make current

This value specifies the inrush current that may flow under defined conditions (voltage, power factor, duration) when the contact closes. The relay must work faultlessly afterwards.

The inrush current may often be much higher than the continuous current in an application. The inside resistance of the power source is also of important influence. Typical values are:

Load	Typical inrush current (Factor Inrush/Nominal)	Typical decay time $I_{in} \rightarrow I_{nom}$
Resistive (ohmic)	1,0	–
Tungsten light bulb	10...15	0,3 s
Flourescent lamp	5...10	10 s
Power saving lamp	20...40	5...20 ms
Hg or Na vapour lamp	1...3	2 min
Magnet coil (AC)	3...20	0,1 s
Motor (AC)	5...10	0,2...0,5 s
Transformer	5...15	0,1 s
Capacitor	20...40	5...20 ms

The inrush current is also dependant whether or not an additional device or ignition device is installed, such as a mercury ballast at mercury vapour lamps, which causes an inrush current of 20...40 times the nominal current over 10 ...30 ms. It is highly recommended to take note of and to measure the detailed relation between current and time (at AC also depending on the phase angle at the moment of switching) when choosing a relay.

A reduction of inrush currents can be achieved by current limiting components, e.g. inductors or NTC resistors.

Load limit curve at DC

→ Arc

Make contact

The contact is closed when the relay is in on position and open when the relay is in off position; → contact assembly.

Material transfer

→ Net metal transfer

Mechanical endurance (mechanical life)

Number of → operations which the relay survives when the contacts do not switch a load.

Mechanical indicator of contact position

Mechanical indicator in relays (mostly industrial relays) which is linked to the contacts and shows their position.

Metal transfer

→ Net metal transfer

Minimum contact load

Limit of load voltage, current and power below which a reliable switching function is no longer guaranteed due to contact material and relay construction. Below this limit inadmissible high contact resistance may occur. When judging this, it has to be considered how much voltage drop at the closed contact condition can be accepted in practical application.

Monostable relay

Electrical relay whose contact returns to initial condition after removal of coil energization.

Must operate value

→ Operate value

Must release value

→ Release value

Net metal transfer

During the switching procedure the → arc heats up the two contacts differently, depending on load and polarity. This results in a material transfer from the hotter to the cooler electrode. With higher DC loads on the contact, a pip is built up, the other contact loses material and it creates a crater. Thus the contacts may get hooked to each other. Also the danger of welding at the pip is increased. In addition the → dielectric strength of the opened contact is lowered. With AC and a random switching mode (no → phase synchronization) the polarities at the contacts are distributed statistically equal, no material transfer occurs. When the switching is synchronized to the AC load voltage (that means always at the same point on the sine wave) even at AC load a material transfer may occur; → phase synchronization.

Nominal coil power

Power in a coil at +20 °C when nominal voltage is applied to a coil having nominal resistance.

Nominal voltage (at coil)

Useful rounded value of the energizing quantity, it is used to classify standard versions and is mostly used as a reference value for other measurements.

Nominal voltage (at contact)

Useful rounded value of load voltage which classifies a relay contact with regard to its use.

Non-polarized relay

The polarity of coil energization does not matter.

Non-release value (non-release voltage)

Voltage (rarely current) at the relay coil, at which a relay (after short pre-energization with nominal value) still stays in operate condition (at no shock and no vibration). Usually this value is not guaranteed for → all-or nothing relays. If an application relies on a non-release value (e.g. reduced voltage or pulsed voltage) a discussion with the relay supplier is recommended.

(to) Operate

Change of contact position from initial condition (e.g. → make contact open) to operated condition (e.g. make contact closed), achieved by applying the → input energizing quantity to the relay coil.

Operate class

Classification of the operate value according to IEC 255 / EN 60255 / VDE 0435.

Operate power

Electrical power when the operate value is applied to a relay coil (having nominal coil resistance) at reference temperature (+20 °C).

Operate time

Time between application of nominal energizing quantity (e.g. nominal voltage) to the relay coil at a temperature of +20 °C and the first opening of the break contact or the first closing of the make contact. → Bounce time is not included. At increased coil energization the operate time is reduced substantially.

Operate value, mostly operate voltage

Minimum allowed value at the coil which guarantees that the relay → operates at reference temperature (temperature of the coil: +20 °C).

The actual value for a relay may be below this specified value. At this specified value each relay must have operated. At coil temperatures which are different from +20 °C the operate voltage of relays with DC coils has to be multiplied by a correction factor according to this diagram:

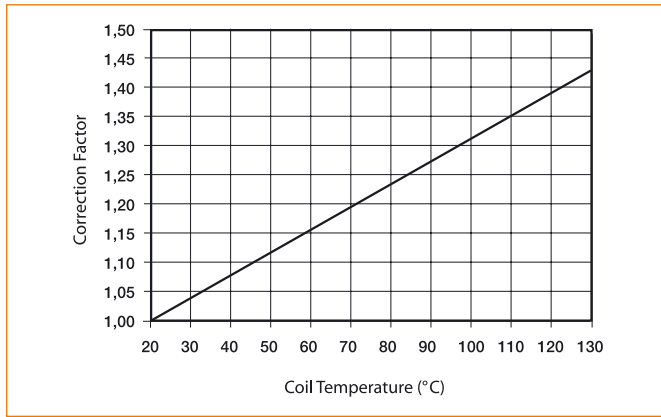

If due to a pre-energization the relay coil has not yet cooled down to ambient temperature, the calculation has to be made based on the actual coil temperature. When the data sheet for a particular relay does not show correction factors, a rough calculation can be made: coil temperature = ambient temperature + temperature increase according to the → temperature rise value. The correction factor to get the necessary operate voltage can be taken from the diagram. With relays having AC coils the temperature dependant deviation of the operate voltage is much lower because the heat-related resistive part of the → coil resistance is clearly lower than the inductive part (which is not dependant on the temperature).

AC coils require higher operate power.

Operation

One → operate and afterwards → release event of a relay, caused by switching on and off of the → input energizing quantity.

Operative range of coil voltage

It depends on the → ambient temperature. With some relays the values and correction factors can be found on the detailed data sheet. An evaluation regarding minimum necessary coil voltage can be made based on the advice given at → operate value. The maximum allowed voltage has to be chosen in such a way, that the sum of ambient temperature in use and self-heating of the coil (→ temperature rise of coil and heating due to contact load) does not exceed the maximum allowed → coil temperature. If relays are placed directly side by side they may have an influence on each other.

Overvoltage category

Definition according to IEC 664-1 / DIN VDE 0110; 4 categories from I (no overvoltage) to IV (use in equipment which is exposed to lightning overvoltage).

Phase synchronization

If contacts always open and / or close with respect to the same point on the sine wave of the AC load (e.g. always at

maximum of the positive phase), → net metal transfer may occur – including the described risks of reduced → electrical endurance. Possible reasons for phase synchronized switching are e.g.:

- insufficient smoothed voltage at the relay coil
- induction of 50 Hz distortion in cables of sensors
- triggering of the coil signal by a 50 Hz time base.

Phosphorus

Some plastic materials include phosphorus as flame retardant. Due to outgassing of the phosphorus, parts of it may accumulate on the contacts. This may lead to a malfunction of the relay. We strongly recommend avoiding such plastics near the relays.

(to) Pick up

→ Operate

Polarized relay

Its magnetic system contains a permanent magnet, thus the specified coil polarity must be observed; otherwise the relay will not work. If a relay is equipped with additional features like a diode switched in parallel to the coil (→ coil configuration) or an LED indicator, the coil polarity must be observed as well.

Pollution degree

Judgement according to IEC 664-1 / DIN VDE 0110:4 degrees from 1 (no pollution or dry, non conductive pollution only) to 4 (pollution causes steady, lasting conductivity).

Preheating at soldering process

The maximum temperature should not exceed 120 °C on the upper surface of the PCB, while preheating procedure for common wave soldering processes.

Rated voltage, rated power

→ Nominal voltage, nominal power

Reduction factor for electrical endurance at an inductive AC load

→ Electrical endurance

Relay

→ Electrical relay

(to) Release

Change of contact position from operated condition (e.g. → make contact closed) to initial condition (e.g. make contact open), achieved by removing the → input energizing quantity from the coil.

Release time

Time between switching off the coil input quantity (e.g. nominal voltage) at a temperature of +20 °C and the first opening of the make contact respectively the first closing of the break contact. If not otherwise specified, the time is valid for applications not using a → coil configuration. There is no essential dependence on the previously applied coil energization. → Bounce time is not included.

Release value, mostly release voltage

Maximum allowed value at the coil at which it is guaranteed that the relay → releases at reference temperature (temperature of coil: +20 °C). The actual value for a relay may be beyond this specified value. At the specified value each relay must have released. The dependence on temperature is the same as with the → operate value.

(to) Reset

Change of contact position of a → bistable relay from the on state to the off state, caused by applying the input energizing quantity to the reset coil.

Reset voltage

→ Operate voltage at a → bistable relay; when this value is applied to the

Sealing

→ Categories of protection (IEC 61810)

Sensitive version (regarding coil resistance)

With some relay types it is possible to choose between two coils with a different resistance, but with the same nominal voltage. The lower resistance type is called the standard version, the higher resistance type is called the sensitive version. In some cases the sensitive version has a higher → operate value.

Set voltage

→ Operate voltage at a → bistable relay

Shock resistance (mechanical)

It specifies at which mechanical shock (multiple of gravitational acceleration 'g' at half sine wave form shape and duration 11 ms) the closed contact has still not opened (failure criteria: contact interrupted for > 10 μs) or no damage occurs; → handling guidelines → application guidelines.

Silicone based substances

→ Application guidelines
→ Handling guidelines

Single contact (single button)

Contrary to the → bifurcated contact, each contact circuit uses one contact only. It is useful for all load ranges, at low loads a bifurcated contact may be of benefit.

Snubber

→ Driver protection circuit

Spark quench device

→ Driver protection circuit

Standard version (regarding to coil resistance)

With some relay types it is possible to choose between two coils with a different resistance, but with the same nominal voltage. The lower resistance type is called the standard version, the higher resistance type is called the sensitive version.

Switching current (maximum)

Current (AC or DC) which can be switched on and off by a relay contact. Somewhat higher values are usually allowed at reduced → ambient temperature and reduced → electrical endurance.

Switching power (maximum)

Electrical power which can be switched on and off by a relay contact for a specified → electrical endurance. At higher loads the electrical life is reduced substantially. Due to the → arc, the DC power (published in unit 'W') is often lower than the AC power (published in unit 'VA'). It has to be observed that the value of maximum power is valid for a certain voltage; it may be lower e.g. at DC or higher voltages.

Switching rate (maximum)

Highest switching frequency (number of → operations per time) which is allowed for a relay. Due to considerable warming by the → arc at intermediate and high loads a maximum switching rate of e.g. 10 operations per minute is allowed; at very low loads however e.g. 20 operations per second may be allowed.

Switching voltage (maximum)

Voltage (AC or DC) which can be switched on and off by a relay contact. Somewhat higher values usually do not harm the relay. Due to the → arc, the DC value is often lower than the AC value.

Temperature rise

Ratio between temperature increase of the coil winding and coil input power (referred to coil temperature +20 °C, declared in K/W). Sometimes also specified as temperature increase at nominal coil energization.

Termination

Print terminals: Relays are to be soldered to a PCB; mechanical fastening and electrical connection are made by the PCB.

Print terminals plus quick connect termination: Relays are to be soldered to a PCB; the electrical connection for high currents is made via the quick connects, small currents (e.g. for monitoring purpose) are conducted via the PCB.

Quick connect termination: Electrical connection via quick connect terminals only, either by single connectors or by sockets.

Test push button

Push button (usually in industrial relays) which is accessible from the outside; if it is pressed by hand or with a tool, it switches the contact circuit of a deenergized relay from off to on condition. Sometimes it can be locked mechanically. The test push button helps to trace the current paths in a switch board.

Thermal behaviour

→ Operate value, → limiting continuous thermal withstand value; → coil temperature; → temperature rise; → ambient temperature

Thermal resistance of the coil

→ Temperature rise

Tracking resistance

Measuring unit for forming of conductive tracks on insulating materials. An aqueous solution drops on a test sample and leads to electrolytic conduction and to conducting tracks when voltage is applied. The result is presented as PTI or CTI value, depending whether the test has been made at one voltage only or whether a test series has been made. For certain applications the applicable standards specify minimum values.

Transit time (transfer time)

Time during which both circuits of a → change-over contact (→ contact assembly) are open.

Ultrasonic cleaning

→ Handling guidelines

Utilization category

The standard EN 60947 / DIN VDE 0660 classifies the contact loads into categories (e.g. AC-1, AC-15, DC-1, DC-13). These categories are basically valid for contactors, but sometimes also applied on relays.

(to) Vent a relay

To open a vent hole on a sealed relay after soldering it to the PCB (which has possibly been cleaned or varnished). The relay may only be opened by cutting off the vent nib; → application guidelines

Vibration resistance

It specifies the amplitude or the acceleration in a defined frequency range at which the closed contact should still not open (failure criteria: contact interrupted for > 10 µs). Increased values of vibration parameters may specify the limit at which damage should still not occur. → application guidelines

Wave form of coil energization

Voltage or current should be applied in rectangular wave form. If the coil energization is slowly ramped up or down, the → operate, release and transit times are enlarged; this may result in lower → electrical endurance. Relays with AC coils would run through a range in which the relay contacts buzz; at higher loads they would be subject to extreme wear with the high risk of destruction.

It is recommended to apply at least the nominal energizing quantity. At DC coil energization the ripple should not exceed 5 %; if transformer and rectifier are used to operate the relay, an adequate smoothing capacitor has to be provided.

The use of a high frequently pulsed DC voltage has to be investigated carefully in the relevant practical application.

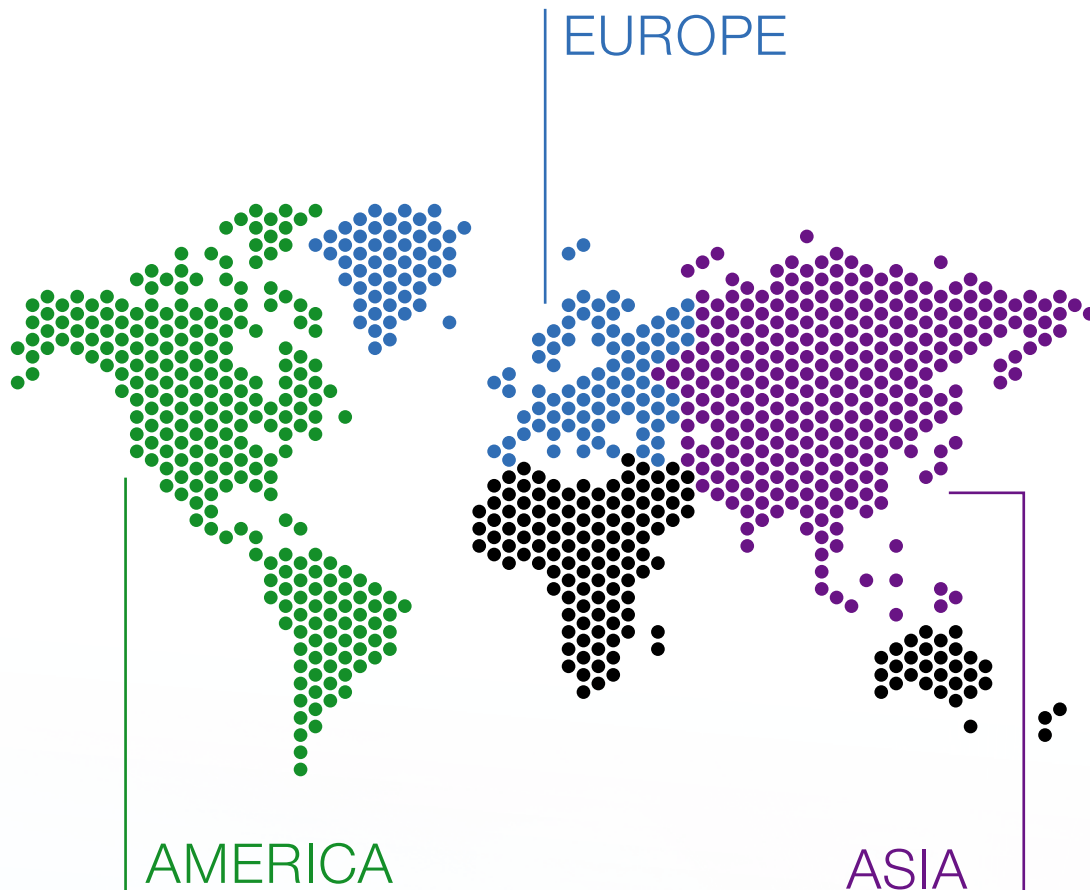

Enjoy the technical competence and the absolutely reliable service of a worldwide operating group!

- Global engineering departments with well experienced engineers and sophisticated measuring equipment
- Excellent guidance in choice of products
- Customer specific tests
- Additional securing the components quality by continuous incoming inspection
- New designs and modifications of existing parts according to European and international standards or according to customer specifications
- Well assorted warehouse of standard components
- Fast and upon request delivery on a given day

DIN EN ISO 9001:2008 certified



ZETTLER electronics GmbH

Junkersstr. 3
82178 Puchheim bei München
GERMANY
Phone: +49 89 / 800 97-0
Fax: +49 89 / 800 97-200
office@ZETTLERelectronics.com
www.ZETTLERelectronics.com

ZETTLER electronics B.V.

Dorpstraat. 51
2761 AA Zevenhuizen
NEDERLAND
Phone: +31 180 / 310 663
Fax: +31 180 / 311 048
office@ZETTLERelectronics.nl
www.ZETTLERelectronics.nl

ZETTLER electronics Poland sp.z.o.o.

Osadników Wojskowych 40
86-200 Zary
POLAND
Phone: +48 68 / 479 1437
Fax: +48 68 / 479 1439
office@ZETTLERelectronics.pl
www.ZETTLERelectronics.pl

Companies of the ZETTLER Group

AMERICA:

ZETTLER COMPONENTS
AMERICAN ZETTLER
AZ DISPLAYS
ZETTLER CONTROLS
ZETTLER MAGNETICS

ASIA:

Xiamen ZETTLER electronics Co., Ltd.
ZETTLER electronics Shanghai
Ningbo ZETTLER electronics Co., Ltd.
ZETTLER electronics (HK) Limited

A member of the ZETTLER Group

www.ZETTLERelectronics.com
www.zettler-group.com